

GIVI® S950

PORTA NAVIGATORE - SUPPORT FOR GPS
SUPPORT POUR GPS - GPS TASCHE
PORTA-NAVEGADOR

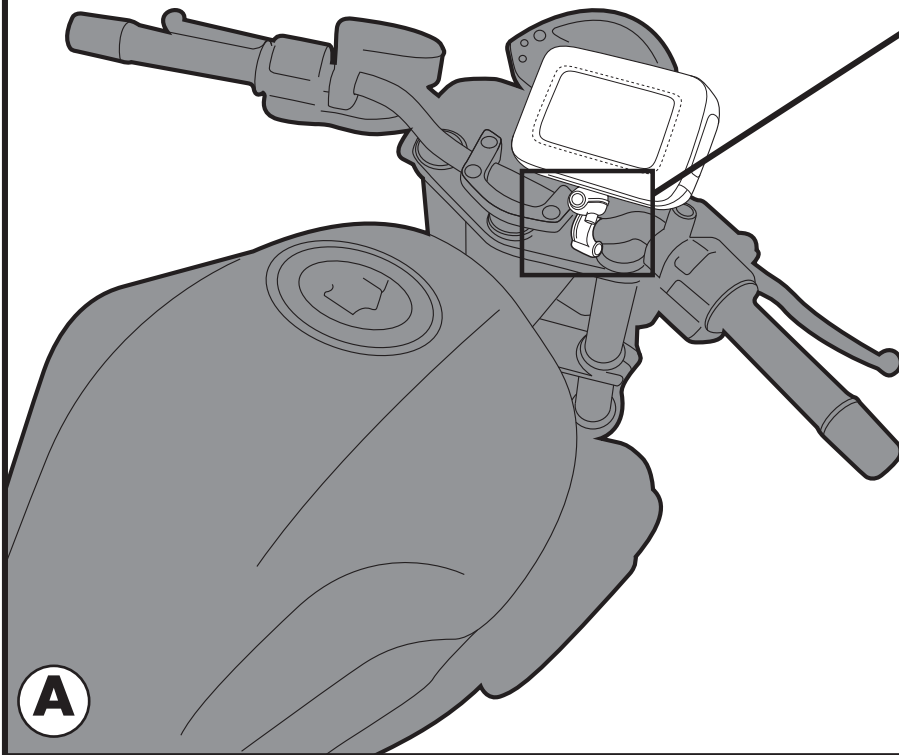
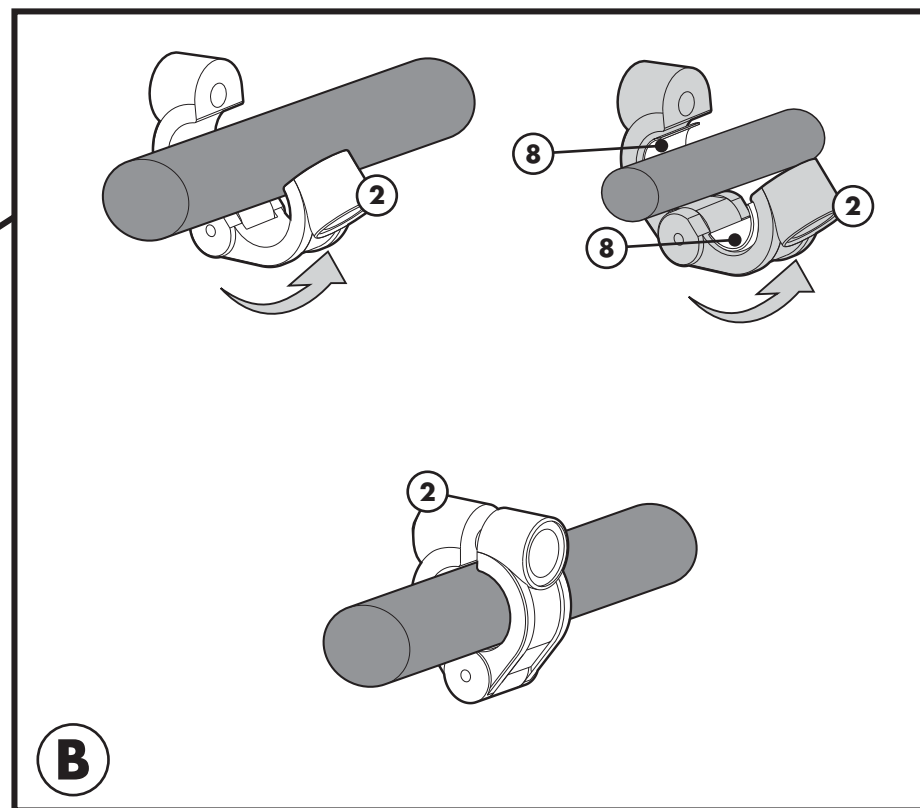
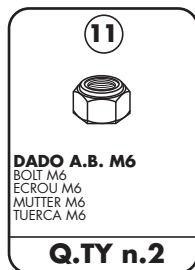
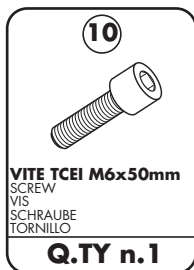
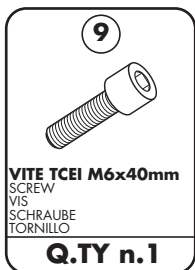
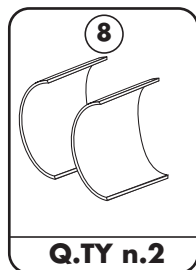
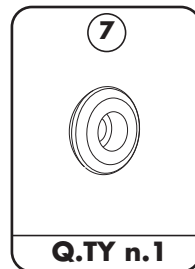
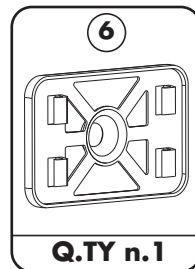
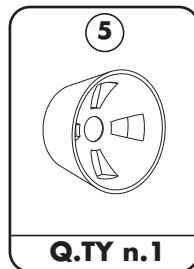
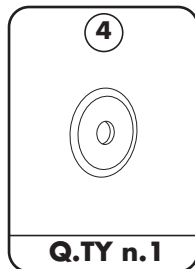
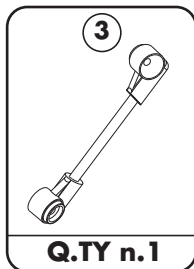
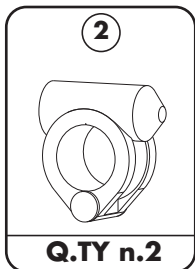
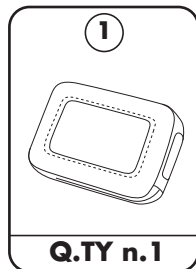

GIVI® S950

PORTA NAVIGATORE - SUPPORT FOR GPS
SUPPORT POUR GPS - GPS TASCHE
PORTA-NAVEGADOR

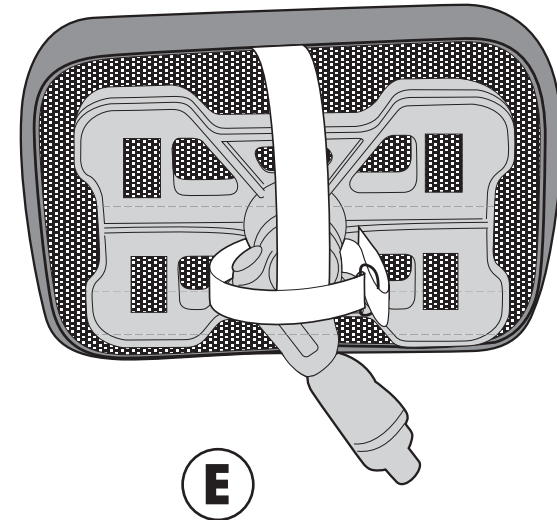
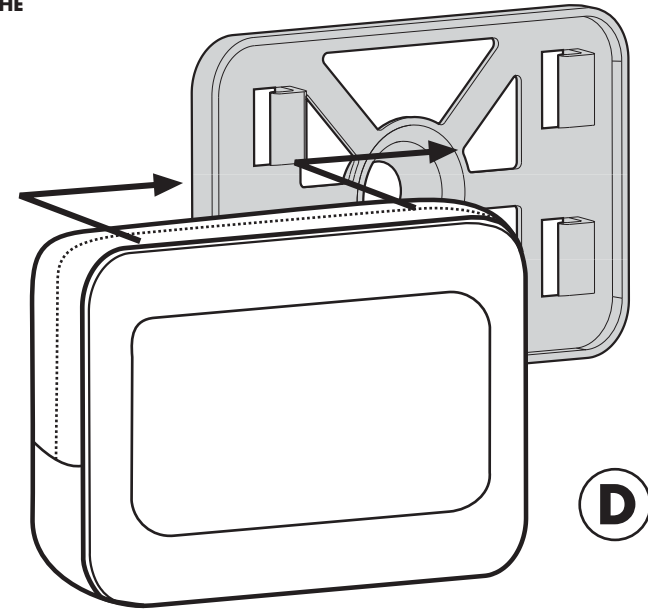
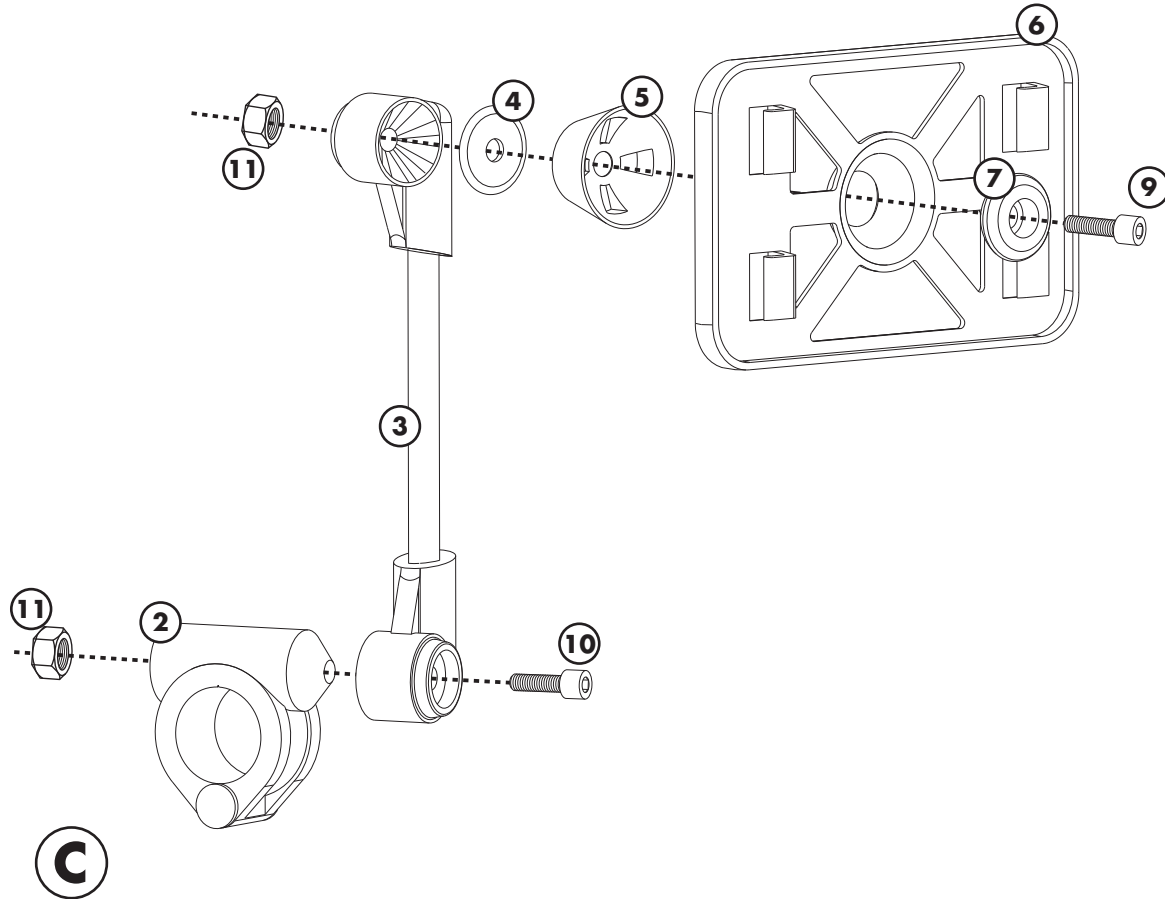

I ISTRUZIONI DI MONTAGGIO

1. STACCARE LA PARTE 6 DAL PORTANAVIGATORE, SI SGANCIA FACENDOLA SCORRERE LATERALMENTE;
2. ASSEMBLARE LA PARTE n°6 A TUTTO IL RESTO DEI COMPONENTI (FIG C);
3. FISSARE TUTTO IL SUPPORTO AL MANUBRIO VALUTANDO IL DIAMETRO DEL MANUBRIO ED, ALL'OCCORRENZA, UTILIZZARE GLI SPESSORI N°10;
4. AGGANCIARE IL PORTANAVIGATORE (PARTICOLARE 1) AL SUPPORTO N° 6 MONTATO FACENDOLO TRASLARE LATERALMETNE (FIG. D);
5. RACCOMANDIAMO DI ASSICURARE IL PORTANAVIGATORE AL SUPPORTO (FIG. E) UTILIZZANDO L'APPOSITA CINGHIETTA.

GB MOUNTING INSTRUCTIONS

1. REMOVE PART 6 OF THE GPS SYSTEM CARRIER, YOU CAN RELEASE IT BY SLIDING IT SIDEWAYS;
2. ASSEMBLE THE REST OF THE COMPONENTS (FIG C) AS IN THE OUTLINE
FIX THE WHOLE SUPPORT TO THE HANDLEBAR
3. ESTIMATE THE DIAMETRE OF THE HANDLEBAR AND IF NECESSARY USE THE ADJUSTING CUFFS (10)
4. CONNECT THE GPS SYSTEM CARRIER (1) TO THE MOUNTED SUPPORT (6) BY SIDING IT SIDEWAYS (FIG D)
5. WE RECOMMEND TO FASTEN THE GPS SYSTEM CARRIER TO THE SUPPORT (FIG E) USING THE STRAP PROVIDED